

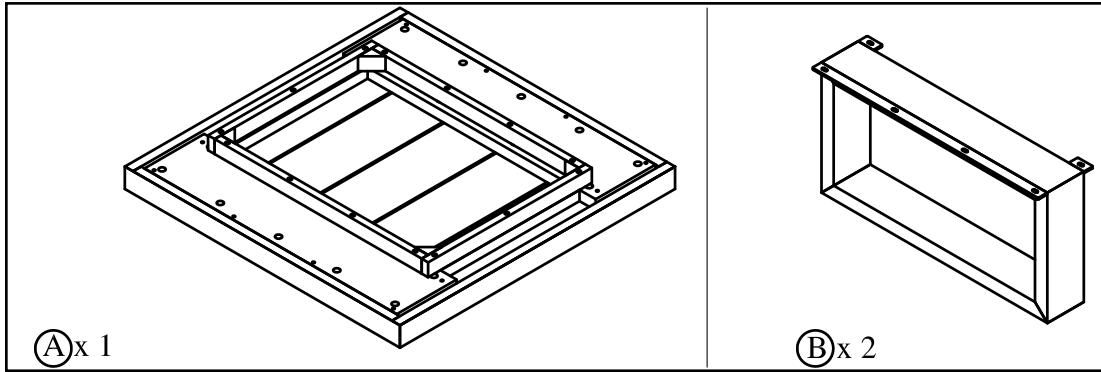





10 MN



NO.	HARDWARE LIST	Q'TY
1	Bolts M6*30 	12 PCS
2	Flat Washer Ø8/19x1.5 	12 PCS
3	Allen key K4x25x90 	1 PC

