

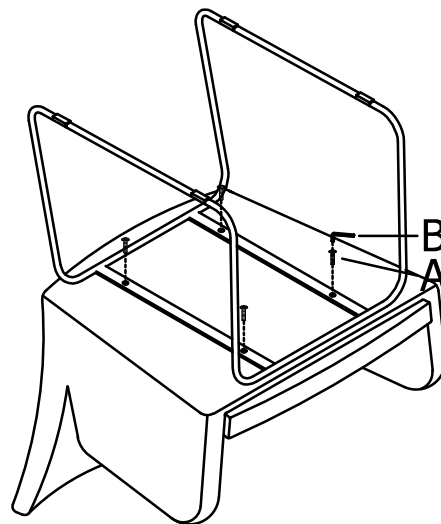

STEP1

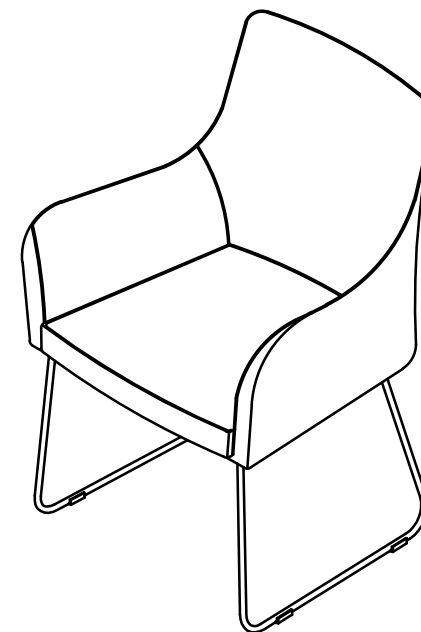

STEP2



STEP3

A		M6*16	4
B		4#	1