

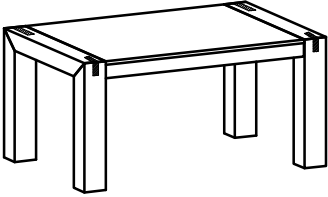



## ASSEMBLY INSTRUCTION

<p>ODERZO-K</p> 	<p>A. (M10 x 50) x 10</p> 	<p>B. (Ø10) x 10</p> 	<p>C. (Ø10) x 10</p> 
---	---	---	--

  (M17) x 1	 (1) x 1	 (2) x 2
---	--	--

**1**

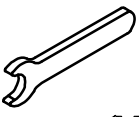
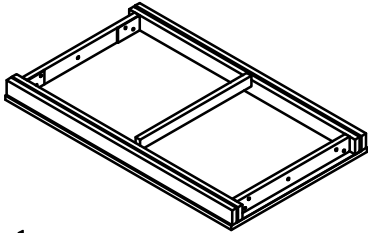
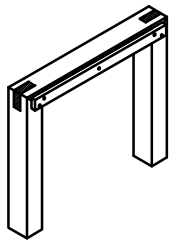
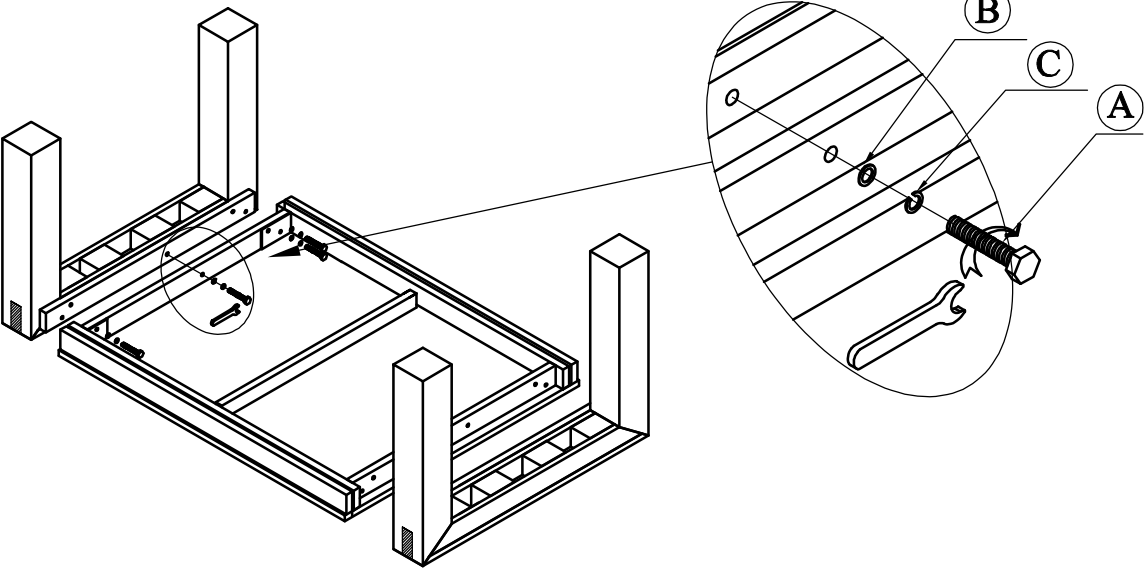

**2**

