

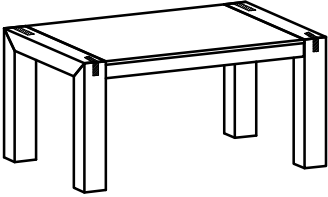



## ASSEMBLY INSTRUCTION

<p>ODERZO-L</p> 	<p>A. (M10 x 50) x 12</p> 	<p>B. (Ø10) x 12</p> 	<p>C. (Ø10) x 12</p> 
---	---	---	--

  <p>(M17) x 1</p>	 <p>(1) x 1</p>	 <p>(2) x 2</p>
--	--	--

**1**

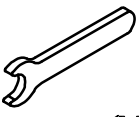
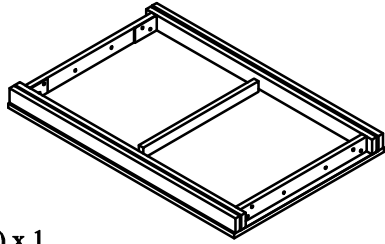
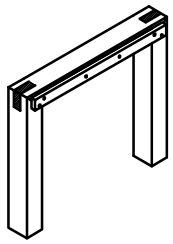
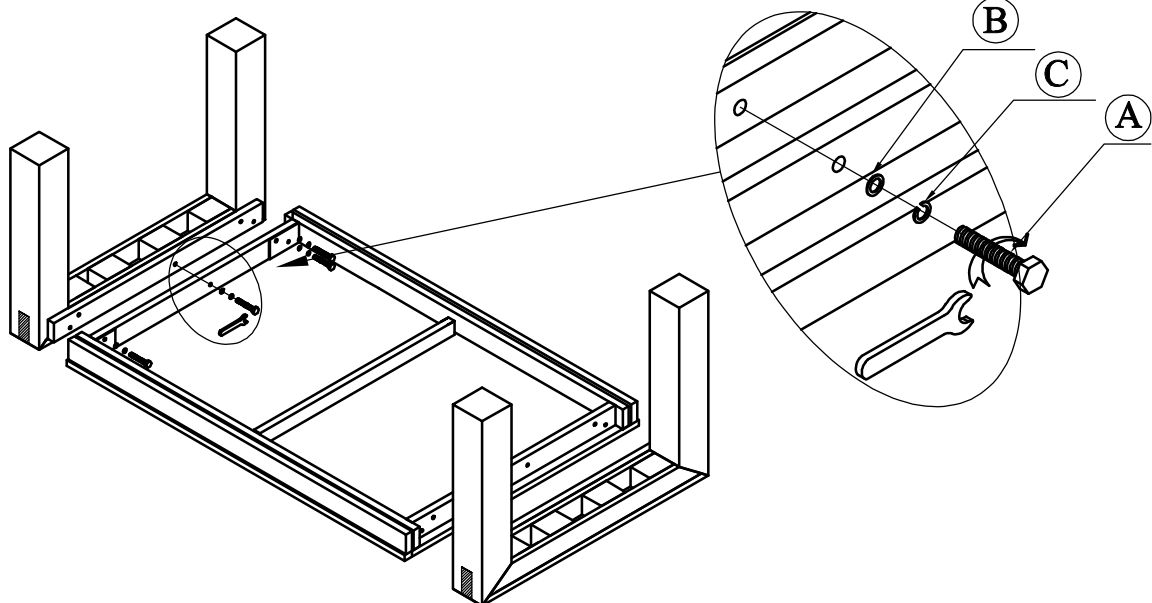

**2**

