

HINTS & TIPS

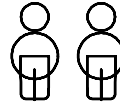

Please retain your assembly instruction for future use



This assembly requires two people

PRODUCT ASSEMBLY - Step by step guide

Step 1

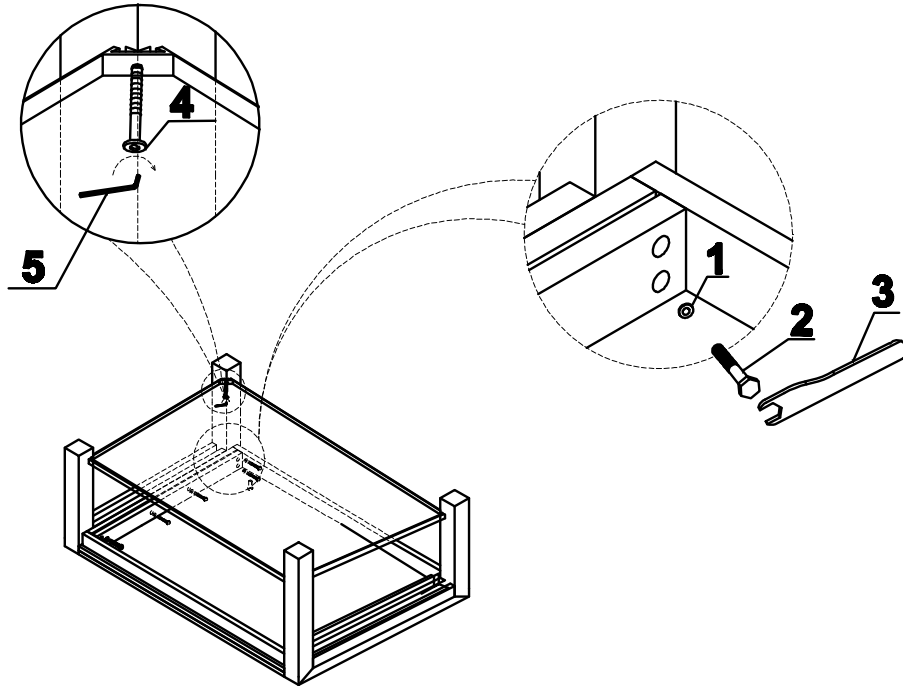

01  **X 12**
Washer

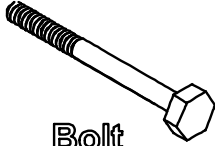
02  **X12**
Bolt

03  **x1**
Spanner

04  **X04**
Hexagon nut

05  **X01**
Hexagon key

Step 2

